

# Guidelines To Gas Metal Arc Welding (GMAW)



## **WARNING**

**ARC WELDING** can be hazardous.

This document contains general information about the topics discussed herein. This document is not an application manual and does not contain a complete statement of all factors pertaining to those topics.

This installation, operation, and maintenance of arc welding equipment and the employment of procedures described in this document should be conducted only by qualified persons in accordance with applicable codes, safe practices, and manufacturer's instructions.

Always be certain that work areas are clean and safe and that proper ventilation is used. Misuse of equipment, and failure to observe applicable codes and safe practices, can result in serious personal injury and property damage.



# WARNING



## **ELECTRIC SHOCK can kill.**

- Always wear dry insulating gloves.
- Insulate yourself from work and ground.
- Do not touch live electrical parts.
- Keep all panels and covers securely in place.



## **FUMES AND GASES can be hazardous to your health.**

- Keep your head out of the fumes.
- Ventilate area, or use breathing device.
- Read Material Safety Data Sheets (MSDSs) and manufacturer's instructions for material used.



## **WELDING can cause fire or explosion.**

- Do not weld near flammable material.
- Watch for fire; keep extinguisher nearby.
- Do not locate unit over combustible surfaces.
- Do not weld on closed containers.
- Allow work and equipment to cool before handling.

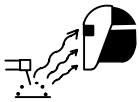

## **ARC RAYS can burn eyes and skin; NOISE can damage hearing.**

- Wear welding helmet with correct shade of filter.
- Wear correct eye, ear, and body protection.



## **MOVING PARTS can cause injury.**

- Keep away from pinch points such as drive rolls.
- Keep all doors, panels, covers, and guards closed and securely in place.



## **HOT PARTS can cause injury.**

- Allow cooling period before touching welded metal.
- Wear protective gloves and clothing.

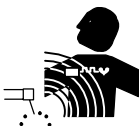

## **MAGNETIC FIELDS FROM HIGH CURRENTS can affect pacemaker operation.**

- Pacemaker wearers keep away.
- Wearers should consult their doctor before going near arc welding, gouging, or spot welding operations.

## **WELDING CURRENT can damage electronic parts in vehicles.**

- Disconnect both battery cables before welding on a vehicle.
- Place work clamp as close to the weld as possible.

See Safety Precautions at beginning of welding power source Owner's Manual for basic welding safety information.

swarn6.2\* 8/92

# 1. Gas Metal Arc Welding (GMAW)

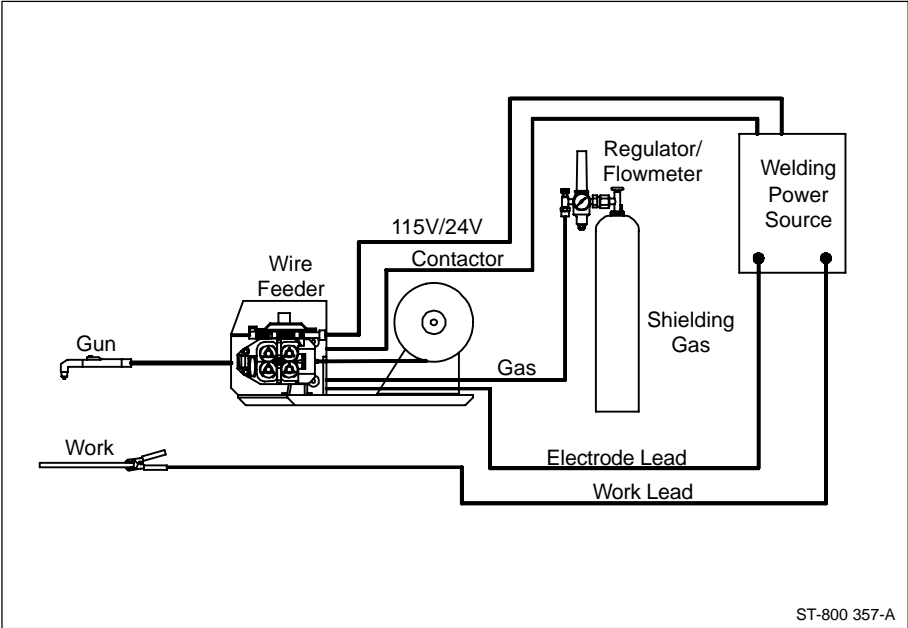

**Figure 1. Typical GMAW Process Connections**

# NOTE



These settings are guidelines only. Material and wire type, joint design, fitup, position, shielding gas, etc. affect settings. Test welds to be sure they comply to specifications.

Material thickness determines weld parameters.

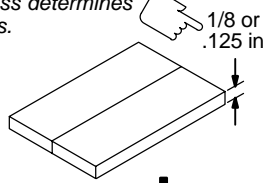

## Convert Material Thickness To Amperage (A)

(.001 in = 1 ampere)  
.125 in = 125 A

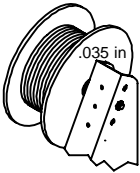

Wire Size	Amperage Range
.030 in	40 – 145 A
.035 in	50 – 180 A
.045 in	75 – 250 A

## Select Wire Size



Wire Size	Recommendation	Wire Speed (Approx.)
.030 in	2 in per ampere	2 x 125 A = 250 ipm
.035 in	1.6 in per ampere	1.6 x 125 A = 200 ipm
.045 in	1 in per ampere	1 x 125 A = 125 ipm

## Select Wire Speed (Amperage)

125 A based on 1/8 in material thickness  
ipm = inch per minute



Low voltage: wire stubs into work  
High voltage: arc is unstable (spatter)  
Set voltage midway between high/low voltage.

## Select Voltage

Wire speed (amperage) controls weld penetration. (wire speed = burn-off rate)

Voltage controls height and width of weld bead.

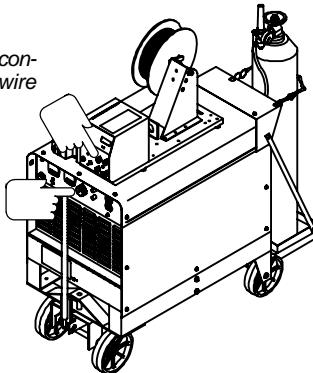

ST-800 354

Figure 2. Typical GMAW Process Control Settings

# NOTE



Welding wire is energized when gun trigger is pressed. Before lowering helmet and pressing trigger, be sure wire is no more than 1/2 in (13 mm) past end of nozzle, and tip of wire is positioned correctly on seam.

- 1 Hold Gun And Control Gun Trigger
- 2 Workpiece
- 3 Work Clamp
- 4 Electrode Extension (Stickout) 1/4 To 1/2 in (6 To 13 mm)
- 5 Cradle Gun And Rest Hand On Workpiece

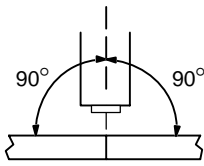
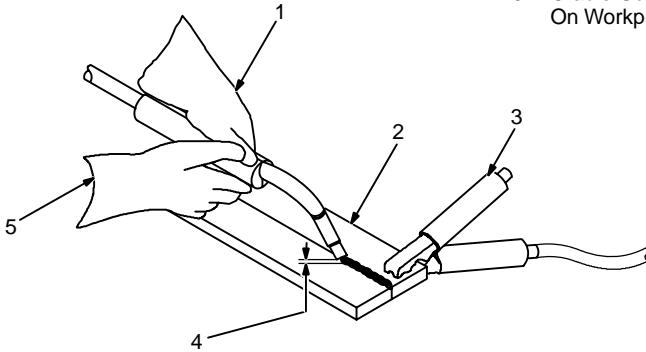

End View Of Work Angle

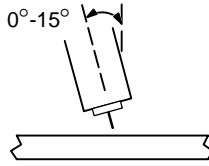

Side View Of Gun Angle

## GROOVE WELDS

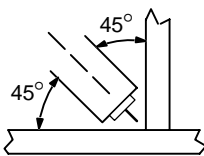

End View Of Work Angle

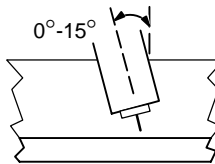

Side View Of Gun Angle

## FILLET WELDS

S-0421-A

Figure 3. Holding And Positioning Welding Gun

# NOTE



Weld bead shape depends on gun angle, direction of travel, electrode extension (stickout), travel speed, thickness of base metal, wire feed speed (weld current), and voltage.

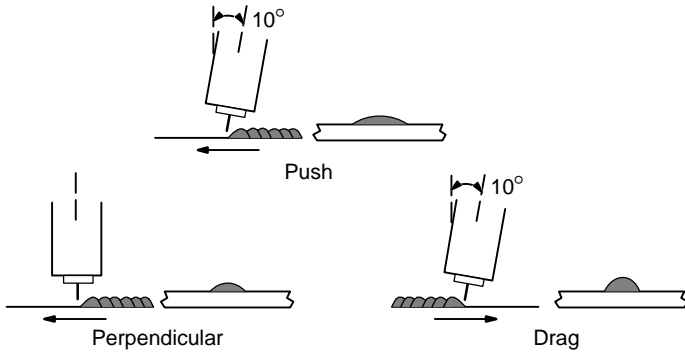

## GUN ANGLES AND WELD BEAD PROFILES

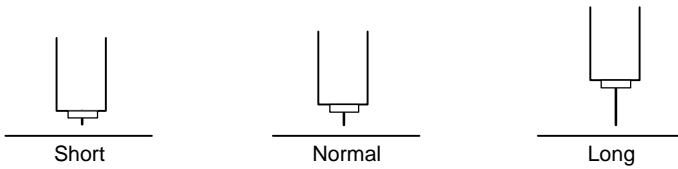

## ELECTRODE EXTENSIONS (STICKOUT)

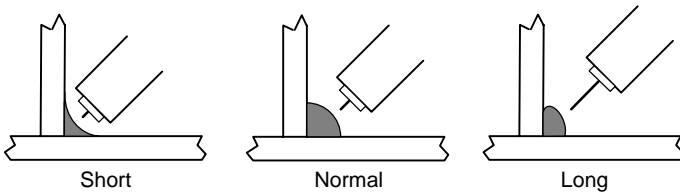

## FILLET WELD ELECTRODE EXTENSIONS (STICKOUT)

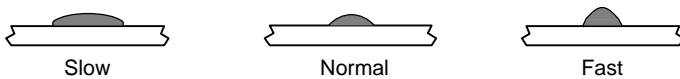

## GUN TRAVEL SPEED

S-0634

**Figure 4. Conditions That Affect Weld Bead Shape**

# NOTE



Normally, a single stringer bead is satisfactory for most narrow groove weld joints; however, for wide groove weld joints or bridging across gaps, a weave bead or multiple stringer beads works better.

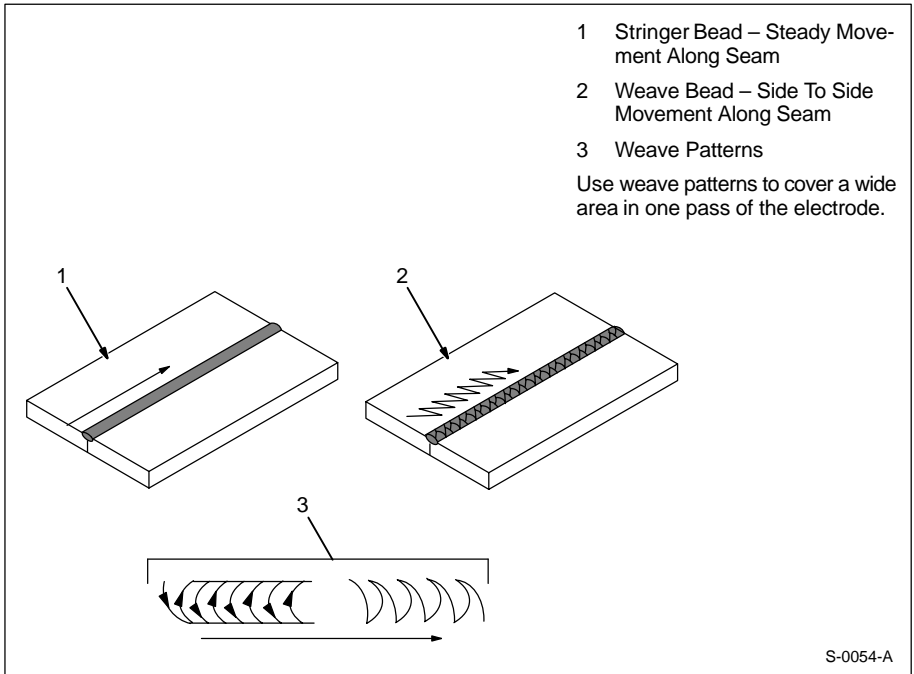

**Figure 5. Gun Movement During Welding**

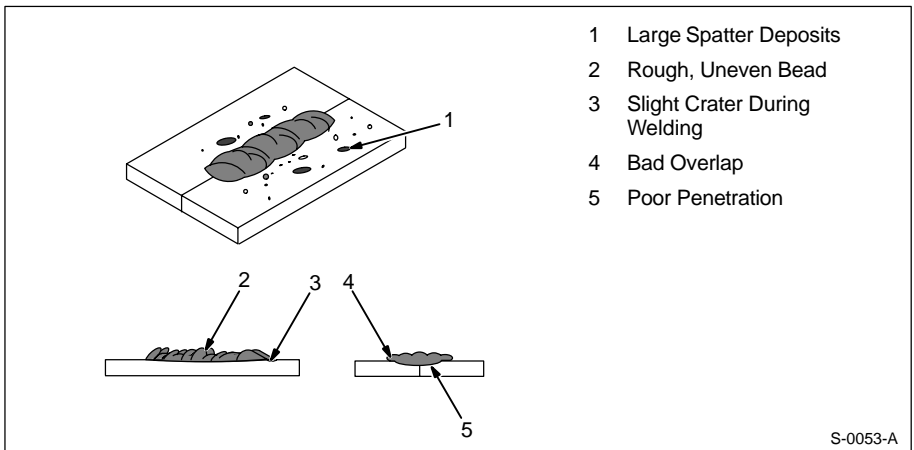

**Figure 6. Poor Weld Bead Characteristics**

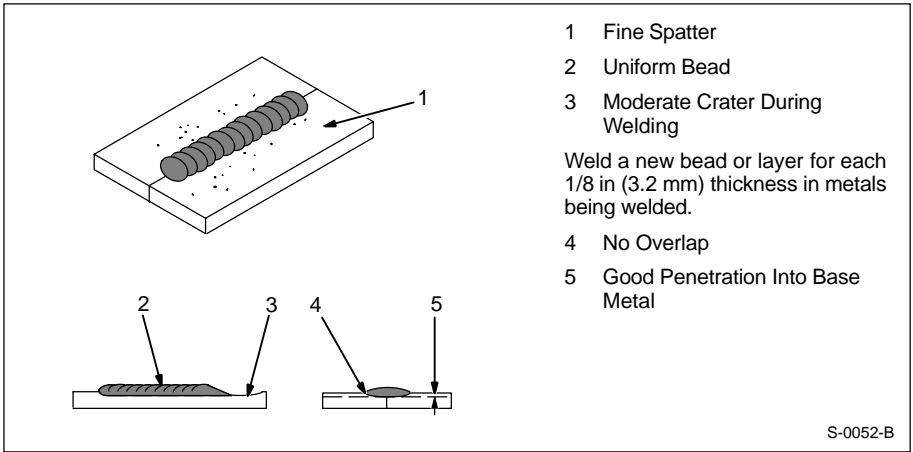

- 1 Fine Spatter
- 2 Uniform Bead
- 3 Moderate Crater During Welding

Weld a new bead or layer for each 1/8 in (3.2 mm) thickness in metals being welded.

- 4 No Overlap
- 5 Good Penetration Into Base Metal

S-0052-B

**Figure 7. Good Weld Bead Characteristics**

## 2. Welding Troubleshooting

**Table 1. Excessive Spatter**

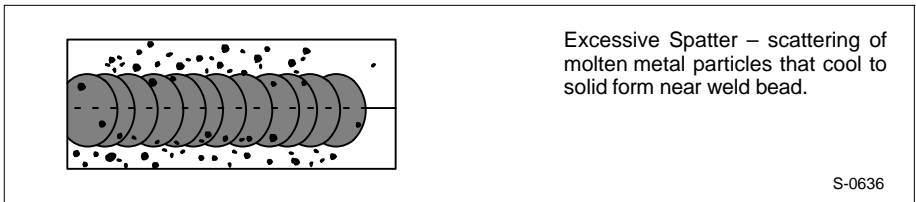

Excessive Spatter – scattering of molten metal particles that cool to solid form near weld bead.

S-0636

Possible Causes	Corrective Actions
Wire feed speed too high.	Select lower wire feed speed.
Voltage too high.	Select lower voltage range.
Electrode extension (stick-out) too long.	Use shorter electrode extension (stickout).
Workpiece dirty.	Remove all grease, oil, moisture, rust, paint, undercoating, and dirt from work surface before welding.
Insufficient shielding gas at welding arc.	Increase flow of shielding gas at regulator/flowmeter and/or prevent drafts near welding arc.
Dirty welding wire.	Use clean, dry welding wire.  Eliminate pickup of oil or lubricant on welding wire from feeder or liner.



**Table 2. Porosity**

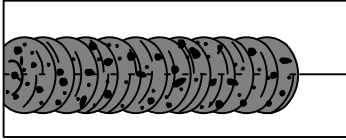

Porosity – small cavities or holes resulting from gas pockets in weld metal.

S-0635

<b>Possible Causes</b>	<b>Corrective Actions</b>
Inadequate shielding gas coverage.	Check for proper gas flow rate.  Remove spatter from gun nozzle.  Check gas hoses for leaks.  Eliminate drafts near welding arc.  Place nozzle 1/4 to 1/2 in (6-13 mm) from workpiece.  Hold gun near bead at end of weld until molten metal solidifies.
Wrong gas.	Use welding grade shielding gas; change to different gas.
Dirty welding wire.	Use clean, dry welding wire.  Eliminate pick up of oil or lubricant on welding wire from feeder or liner.
Workpiece dirty.	Remove all grease, oil, moisture, rust, paint, coatings, and dirt from work surface before welding.  Use a more highly deoxidizing welding wire (contact supplier).
Welding wire extends too far out of nozzle.	Be sure welding wire extends not more than 1/2 in (13 mm) beyond nozzle.

**Table 3. Incomplete Fusion**

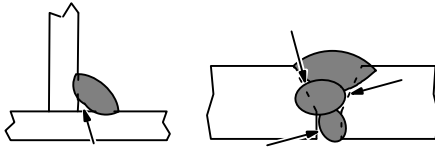

Incomplete Fusion – failure of weld metal to fuse completely with base metal or a preceding weld bead.

S-0637

Possible Causes	Corrective Actions
Workpiece dirty.	Remove all grease, oil, moisture, rust, paint, undercoating, and dirt from work surface before welding.
Insufficient heat input.	Select higher voltage range and/or adjust wire feed speed.
Improper welding technique.	Place stringer bead in proper location(s) at joint during welding. Adjust work angle or widen groove to access bottom during welding. Momentarily hold arc on groove side walls when using weaving technique. Keep arc on leading edge of weld puddle. Use correct gun angle of 0 to 15 degrees.

**Table 4. Excessive Penetration**

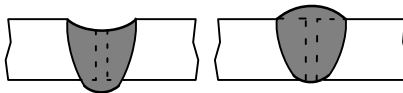

Excessive Penetration      Good Penetration

Excessive Penetration – weld metal melting through base metal and hanging underneath weld.

S-0639

Possible Causes	Corrective Actions
Excessive heat input.	Select lower voltage range and reduce wire feed speed. Increase travel speed.

**Table 5. Lack Of Penetration**

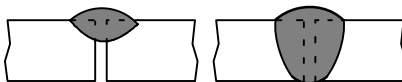

Lack of Penetration      Good Penetration

Lack Of Penetration – shallow fusion between weld metal and base metal.

S-0638

Possible Causes	Corrective Actions
Improper joint preparation.	Material too thick. Joint preparation and design must provide access to bottom of groove while maintaining proper welding wire extension and arc characteristics.

Possible Causes	Corrective Actions
Improper weld technique.	Maintain normal gun angle of 0 to 15 degrees to achieve maximum penetration.  Keep arc on leading edge of weld puddle.  Be sure welding wire extends not more than 1/2 in (13 mm) beyond nozzle.
Insufficient heat input.	Select higher wire feed speed and/or select higher voltage range.  Reduce travel speed.

**Table 6. Burn-Through**

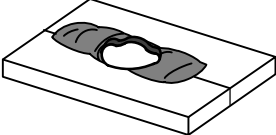
<div style="display: flex; align-items: center; justify-content: space-between;">  <div data-bbox="639 548 969 643"> <p>Burn-Through – weld metal melting completely through base metal resulting in holes where no metal remains.</p> </div> </div> <div style="text-align: right; margin-top: 10px;">S-0640</div>	
Possible Causes	Corrective Actions
Excessive heat input.	Select lower voltage range and reduce wire feed speed.  Increase and/or maintain steady travel speed.

**Table 7. Waviness Of Bead**

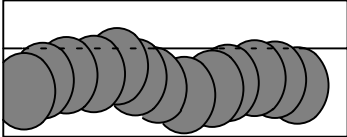
<div style="display: flex; align-items: center; justify-content: space-between;">  <div data-bbox="636 976 969 1045"> <p>Waviness Of Bead – weld metal that is not parallel and does not cover joint formed by base metal.</p> </div> </div> <div style="text-align: right; margin-top: 10px;">S-0641</div>	
Possible Causes	Corrective Actions
Welding wire extends too far out of nozzle.	Be sure welding wire extends not more than 1/2 in (13 mm) beyond nozzle.
Unsteady hand.	Support hand on solid surface or use two hands.

**Table 8. Distortion**

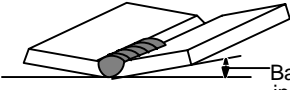
	<p>Distortion – contraction of weld metal during welding that forces base metal to move.</p>
<p>S-0642</p>	
<b>Possible Causes</b>	<b>Corrective Actions</b>
<p>Excessive heat input.</p>	<p>Use restraint (clamp) to hold base metal in position.</p> <p>Make tack welds along joint before starting welding operation.</p> <p>Select lower voltage range and/or reduce wire feed speed.</p> <p>Increase travel speed.</p> <p>Weld in small segments and allow cooling between welds.</p>

---

### 3. Common GMAW Shielding Gases

This is a general chart for common gases and where they are used. Many different combinations (mixtures) of shielding gases have been developed over the years. The most commonly used shielding gases are listed in Table 9.

## NOTES

**Table 9. Shielding Gas**

Gas	Argon	Argon + 1% O <sub>2</sub>	Argon + 2% O <sub>2</sub>	Argon + 5% O <sub>2</sub>	Argon + 8% CO <sub>2</sub>
<b>Spray Arc Steel</b>		Flat & Horizontal <sup>1</sup> Fillet	Flat & Horizontal <sup>1</sup> Fillet	Flat & Horizontal <sup>1</sup> Fillet	Flat & Horizontal <sup>1</sup> Fillet
<b>Short Circuiting Steel</b>					All Positions
<b>Spray Arc Stainless Steel</b>		Flat & Horizontal <sup>1</sup> Fillet	Flat & Horizontal <sup>1</sup> Fillet		
<b>Short Circuiting Stainless Steel</b>					
<b>Spray Arc Aluminum</b>	All Positions <sup>5</sup>				
<b>Short Circuiting Aluminum</b>	All Positions				

1 Globular Transfer

2 Heavy Thicknesses

3 Single Pass Welding Only

4 90% HE + 7-1/2% AR + 2-1/2% CO<sub>2</sub>

5 Also for GMAW-P, All Positions

<b>Argon + 25% CO<sub>2</sub></b>	<b>Argon + 50% CO<sub>2</sub></b>	<b>CO<sub>2</sub></b>	<b>Helium</b>	<b>Argon + Helium</b>	<b>Tri-Mix<sup>4</sup></b>
Flat & Horizontal <sup>1</sup> Fillet		Flat & Horizontal <sup>1</sup> Fillet			
All Positions	All Positions	All Positions			
All Positions <sup>3</sup>					All Positions
			All Positions <sup>2</sup>	All Positions <sup>2</sup>	



**Miller Electric Mfg. Co.**

An Illinois Tool Works Company

1635 W. Spencer St.

Appleton, WI 54912 USA

Tel. 414-734-9821